

Love of life begins with "Rcom"

20

REV. 4.0

DIGITAL EGG INCUBATOR USER'S MANUAL

MAX 20

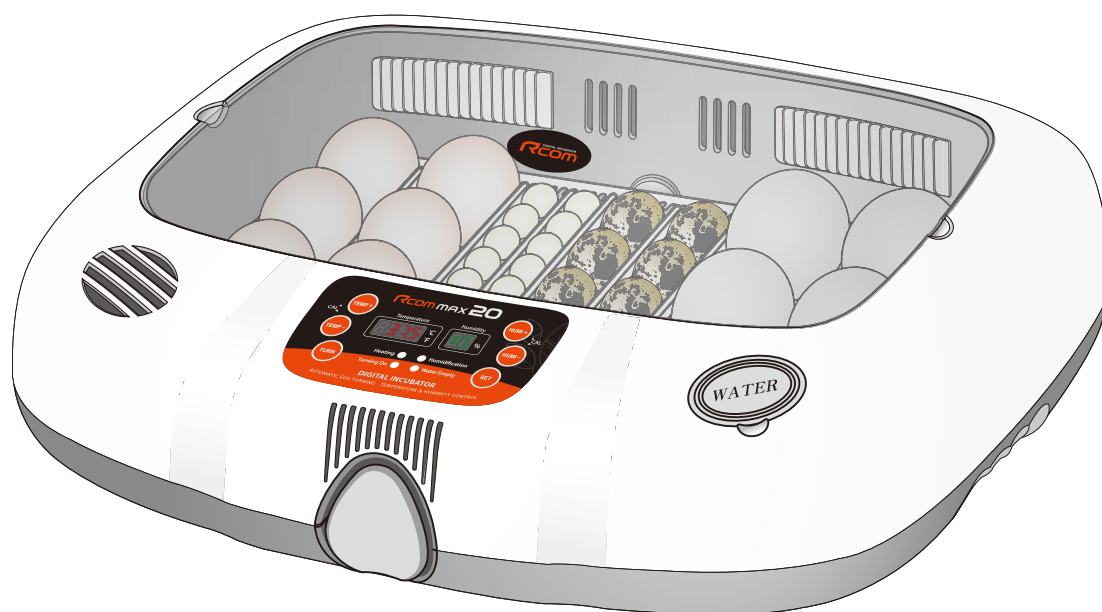

Rcom

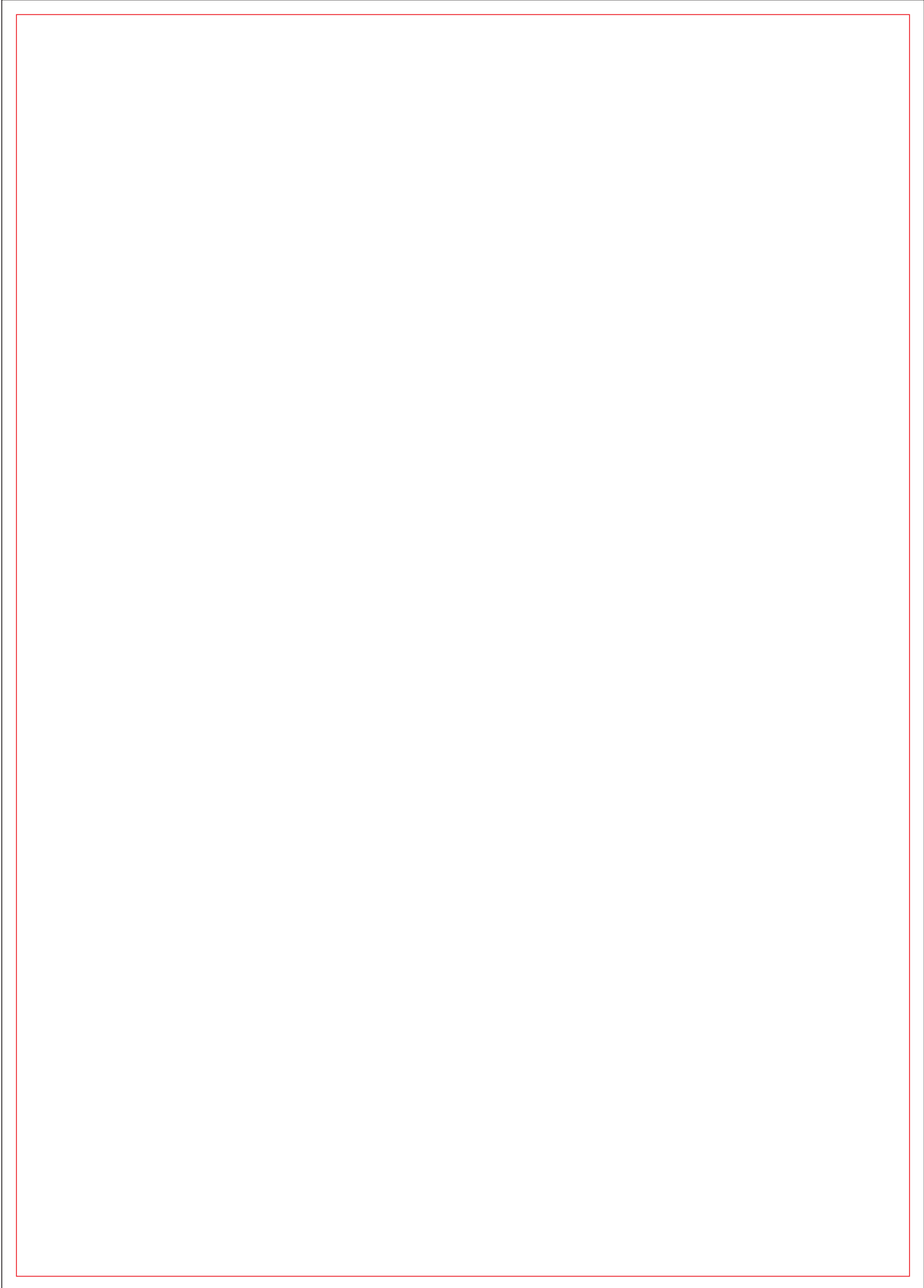



How to use Rcom MAX 20

1. Introduction		Introduction
(1) Rcom 20 Introduction	4	
(2) Safety Precautions	5	
(3) Identification of Parts and Composition	6	
(4) Function of Digital Control & How to Operate	7	Before use
2. Before use		
(1) How to Assemble the Incubator / Egg-Turning plate	8	
(2) What is an incubation room?/ Preparation for Incubation	9~10	
3. Function Settings		Function Settings
(1) Incubator Start&Termination / Return to Factory Setting	11	
(2) Change Cels.& Fahr.		
(3) Temperature & Humidity Setting / How to Set Egg-Turning	12~13	Incubation
4. Incubation		
(1) Humidity & Air Maintenance during Incubation / Maintenance after Hatching	(2) Dew Condensation	
5. How to Clean		How to Clean
(1) How to Disassemble	15	
(2) How to Clean	16	Product Information
6. Product Information		
(1) Servicing / Frequently Asked Questions (FAQ)	17	
(2) Troubleshooting	18	
(3) Specification	19	

⚠ The result of Hatching can be changed by a large numbers of factors. Autoelex Co., Ltd. & our distributors will not take any responsibility for 'Loss of eggs or pet/animal lives' under any circumstances such as 'Hatching/Brooding failures', 'User's carelessness', 'Personal (un-certificated) conversion / alteration', 'Arbitrary using out of the machine's purpose', 'Electric power failure', or 'Malfunctioning'. Please be sure that the machine works without any problem before placing Eggs or Pets(Animals). Also, we strongly recommend you to read the User's Manual carefully to minimize of any failure.

Mark Explanation



Caution : Caution mark against a fault that can cause damage, trouble, or failure of incubation.



Prohibited



It is necessary to keep.



Do not disassemble.



Remove the power cord from outlet.



Do not touch.



Ground Connection for preventing electric shock.



Tip : References or useful suggestions in using Rcom product



Warning of actions which may be dangerous or cause damage to the incubator.

Rcom 20

Thank you for choosing the Rcom incubator.

The Rcom 20 incubator is the first incubator with creditability to have a superior design and function which help in controlling optimum incubation conditions. It has two sensors, one for detecting surrounding environments and the another for internal incubator conditions.

The Rcom20 is designed easy to use and simple to use as a customer orientated product, but please remember that the user's incubation knowledge and proper operation are very important for the best incubation result. Therefore, be sure to read this user's manual carefully before you use this incubator. The Rcom 20 offers optimum incubation conditions, but users need to observe and manage all incubation conditions such as species of eggs, temperature or humidity for each incubation period, and an optimum incubation circumstances .

Features

[Main Features]

- * Outer Temp. Sensor included for Automatic Adjustment of Heating rate responding to Incubation Room Temperature
- * Superior design with convenient operation
- * Optimum air circulation technique with 3 strong BLDC fans
- * Automatic Temp. & Humidity setting and control
- * Body locking device
- * Water supplement alarm function
- * 20 eggs capacity for chicken size eggs (52 Quail egg size / 10 Goose egg size)
- * Antiblastic Humidification method by heating water, which discourages bacterial growth
- * Double-glazed view window for minimizing the influence of outside temperature
- * Enhanced reliability by applying Swiss's Sensirion's 3rd generation temperature & humidity sensor
- * Powerful SMPS application for stable power supply

[Safety Features]

- * Alarm and display function of abnormal incubator temperature caused by sudden fluctuation of ambient temperature
- * Incubation data memory function and power outage notification function in case of power failure
- * Circulation fan cover for safety and electric safety cut-out switch on the upper main body for safety
- * Heater supporter designed for heater tension control and its safety
- * Safety cover applied for protecting humidification unit
- * Humidification unit durability improved by water proof BLDC fan
- * Alarm function when water needs replenishing

[Easy Features]

- * No need of separate humidification unit as it included in main body
- * °C or °F convertible
- * Easy attachment and detachment of double-glazed viewing window
- * Universal egg tray for various size eggs
- * Slide plate with embossed feature for preventing skid
- * Variable air vent for adjusting air supply
- * Bottom body designed for easy cleaning
- * Roller Dividers, which can safely apply egg turning for expensive or rare eggs. (Option)

Electrical hazards

CAUTION Be careful the details below when you use.

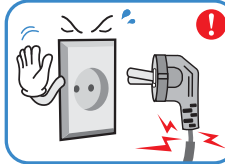

Do not use a damaged power cord or loose outlet.

▶ Risk of electric shock or fire.

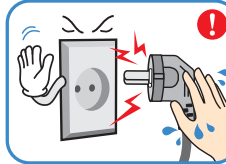

Do not pull the cord when taking out the power cord, and keep wet hands away from connecting plug.

▶ Risk of electric shock or fire.



Never pull the plug out of the outlet during the incubation period.

▶ Incubation will be interrupted.

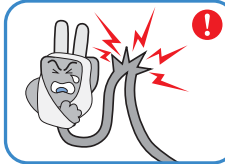

Do not twist or crush electric cord.

▶ Risk of electric shock or fire.

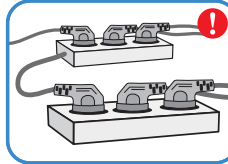

Do not insert multiple connecting plugs in an outlet.

▶ Risk of fire or electrical overload.

Setting Cautions

CAUTION Be careful the details below when you use.



Do not install in dusty or dirty environment.

▶ Risk of damage or fire within the incubator.

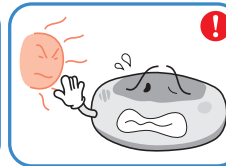

Do not install under the direct sunlight.

▶ Risk of fire or interference with the incubation process.

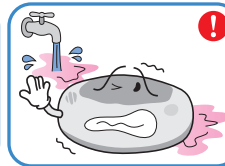

Do not install in moist or humid environment.

▶ Risk of fire or electric shock.



Do not install in excessively cold or hot conditions, cigarette smoke, etc.

▶ Risk of interference with the incubation process.

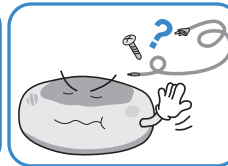

Do not use any other non-standard parts except those provided.

▶ Risk of damage or hatching failure.

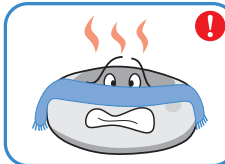

Do not cover the ventilating opening.

▶ Inner temperature can rise, interrupting incubation.

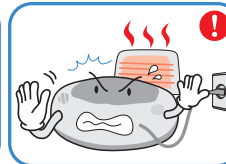

Install away from heat sources.

▶ Risk of damage to the incubator case and interference with the incubation process.



Ensure that the incubator is installed on a stable surface away from edges.

▶ Risk of damage to incubator and eggs and user from accidental knocks or drops.



Do not turn the incubator upside down.

▶ Water will pour out of the incubator, and view window can be dropped or damaged.

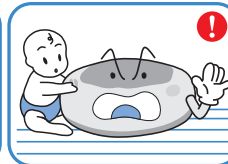

Children should be supervised to ensure that they do not play with the appliance.

▶ Risk of knocking the incubator or accidental interference with the controls.

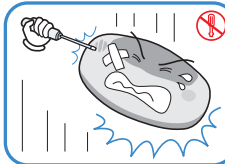

Do not disassemble or modify the incubator in any way.

▶ Risk of electric shock or fire.

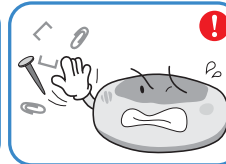

Please ensure that no small objects get into the holes on the incubator.

▶ Risk of electric shock or fire.

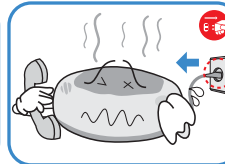

If the incubator sounds strange or emits smoke contact your service center.

▶ Risk of electric shock or fire.



Clean the incubator thoroughly before storing.

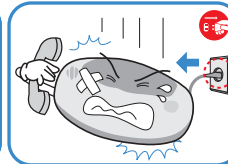

If the incubator requires repair disconnect from the power supply and please contact to your service center.

Cleaning Cautions

CAUTION Be sure to disconnect the electric cord from the outlet before cleaning.

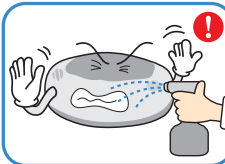

Do not spray cleanser directly on the incubator surface.



Clean the incubator by a soft cloth with a neutral detergent.

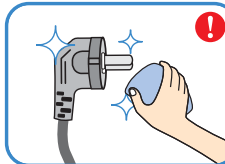

Brush away dust on the plug with a dry cloth.

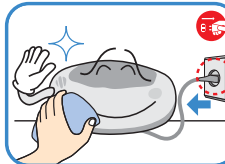

Do not use chemicals like wax, benzene, alcohol, thinner, aromatic, or lubricant, etc.

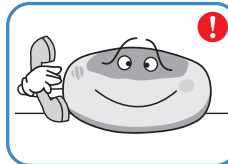

For special cleaning of inner part per year, contact to the service center.

▶ If you don't clean the inside of incubator for a long time, dust can cause some trouble or a fire.

Identification of Parts

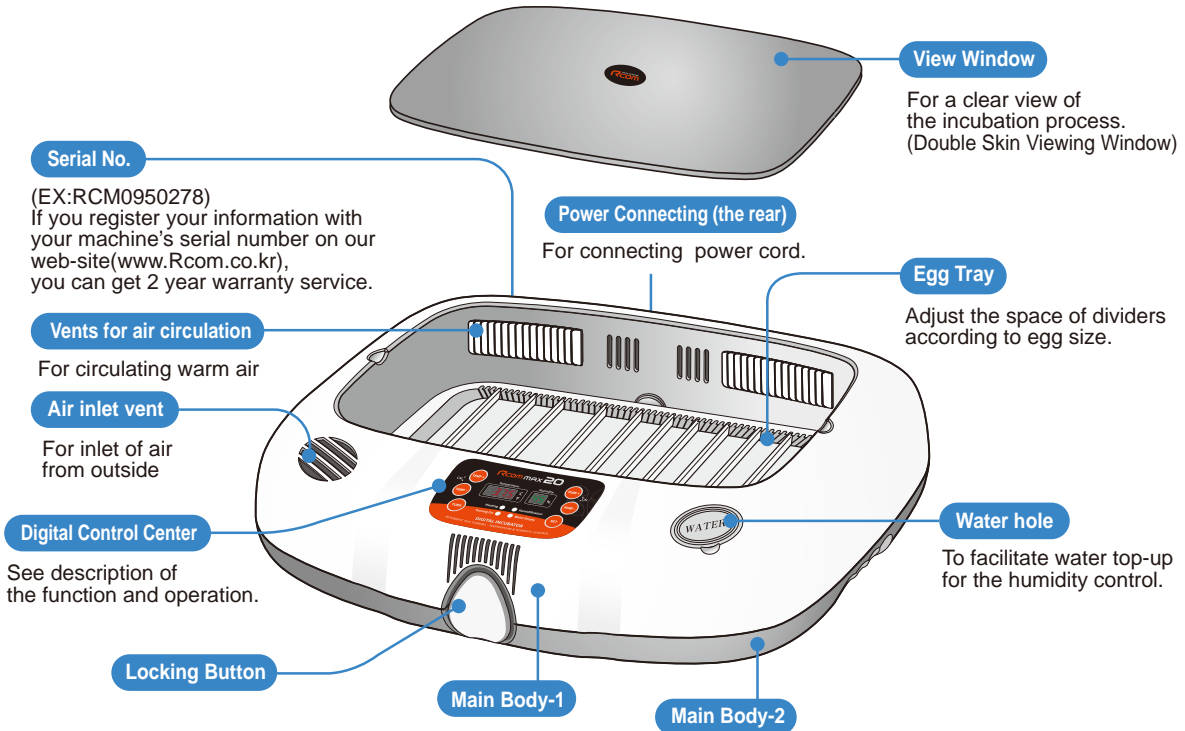

Basic Components

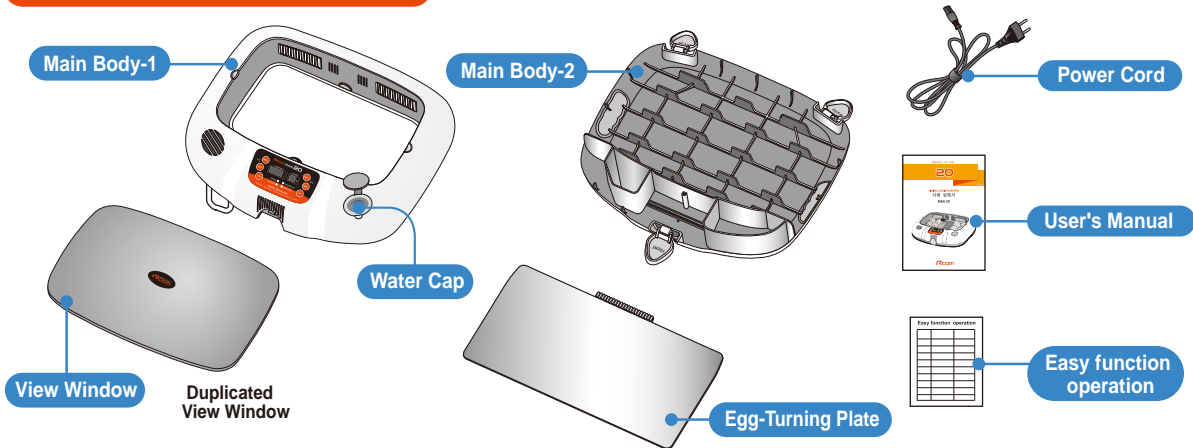

Sold Separately

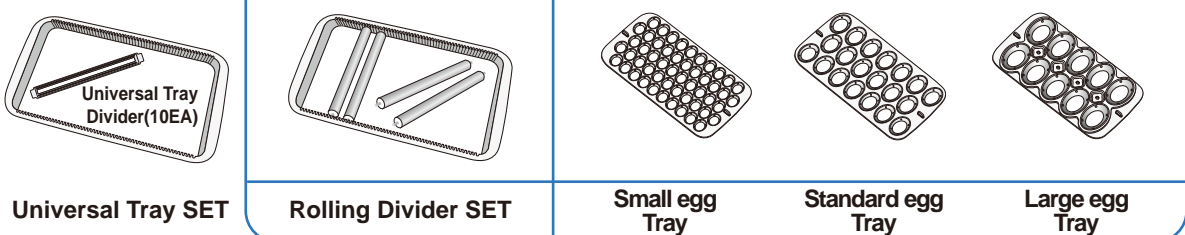

Function of Digital Control & How to Operate

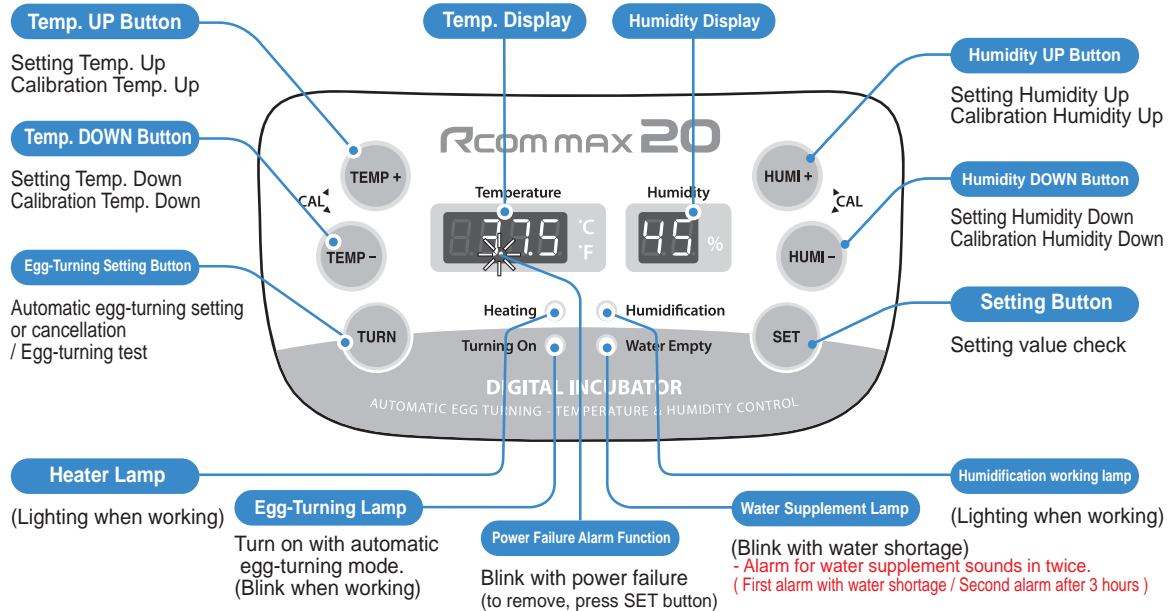

What's 'Temperature&Humidity Setting'?

This is that you set up temp.&humi. As you want to have inside of the machine.

[Function Operation & Explanation]

* put some water after take off label from the back and attach to the window.
 ** If you want to change setting value, keep pressing "SET" button and change the value.

Function	How to Operate	Explanation
Temp. Setting	SET HOLD ▶ TEMP + or TEMP -	Setting of needed temp.
Humidity Setting	SET ▶ HUMI + or HUMI -	Setting of needed humidity.
Egg-Turning Interval Setting	Default setting every 1 hour (Lamp: ON) ▶ SET HOLD ▶ TURN (once 2 Hours) ▶ TURN (2 times 3 Hours) ▶ TURN (3 times(OFF) Lamp OFF) ▶ TURN (4 times every 1 hour (Lamp ON) repeat)	Egg-Turning Interval Setting as required
Egg-Turning Test	TURN 5 Sec.	Egg-Turning Test (once)
Changing Cels. & Fahr.	TEMP + + TEMP - HOLD ▶ CA ▶ SET	Changing Cels. & Fahr.
Initialization (Factory setting)	SET HOLD + POWER IN ▶ rSt	Initialization
How to OFF Humidification Function	SET + HUMI - ▶ 20%	Set Humidity as 20%

How to Assemble

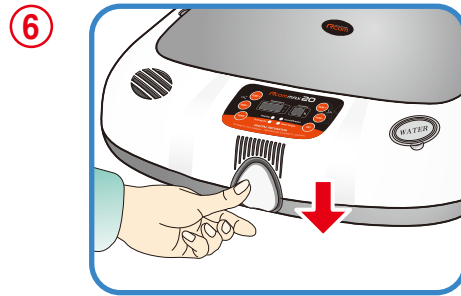
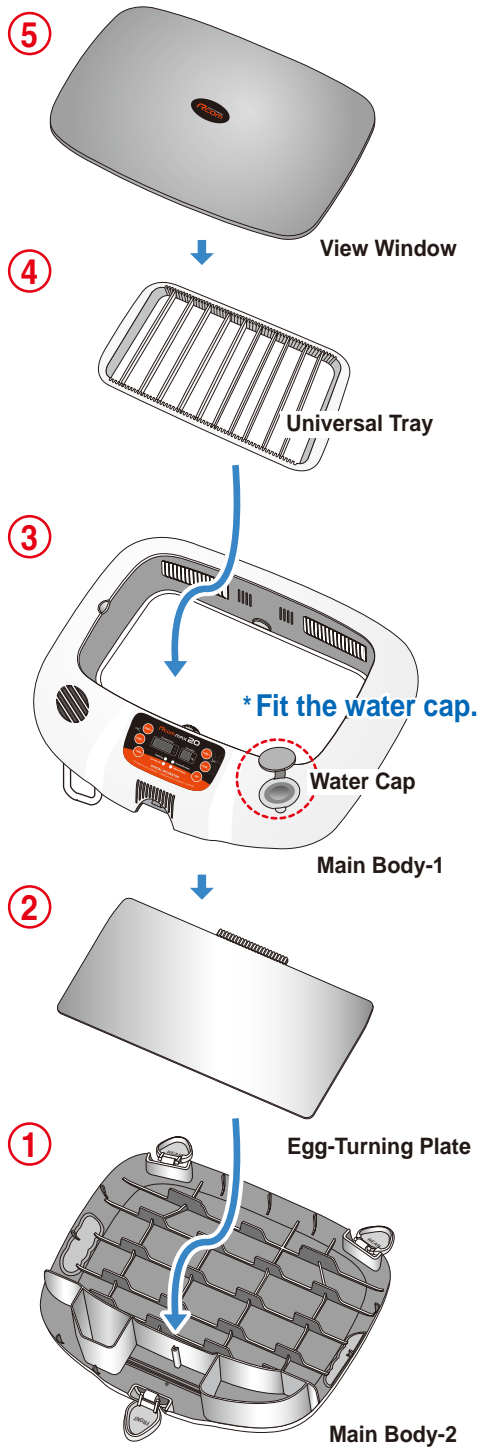

▶ Lock the three locking buttons at the front and rear of the incubator.

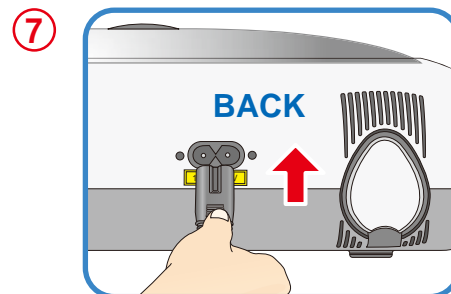

▶ Insert the power cord in the socket at the back of the main body.

⚠ Be careful when you assemble egg turning plate.

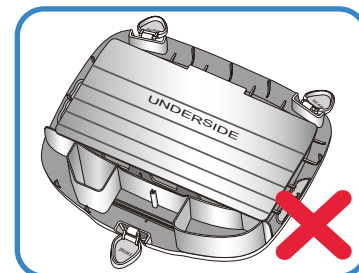
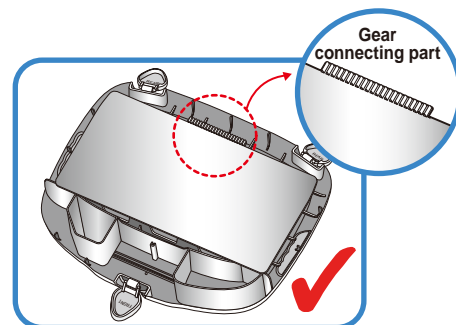

▶ If you do not assemble egg turning place correctly, it can cause incubator failure.

▶ Gear connecting part of egg turning plate must be on the top side.

What's an Incubation Room? / Preparation for Incubation

The Incubation Room is a confined space for setting and operating an incubator. Because the incubation room environment has a considerable effect on hatch rate, it's recommended to control the environment for setting up an incubator; there should be little noise and vibration around and temperature ranging 28°C (82.4°F) with small variation in temperature. Especially, if there are frequent occasions when the temperature drops suddenly at night, compared with daytime, be sure to check from time to time and pay attention so that the incubator is not directly exposed to sunlight during daytime.

- 1 Insert the electric cord in the connecting jack in the back of the main body and put the main plug into a socket. The FND display will light up and show temperature.
- 2 Open the watercap and fill the hole with DISTILLED WATER and refill water after about 5 min. again up to the limit line on its inside mark. (If you refill water during the incubation period, humidity goes down temporarily.)

⚠ After filling up with water, never shake or turn over the main body of the incubator, which would cause water to spill inside the body and could cause a breakdown.

Tip During incubation period, check the DISTILLED WATER water level about every three days and refill water, if necessary. (After you refill water, check again after 5min. and refill again.)

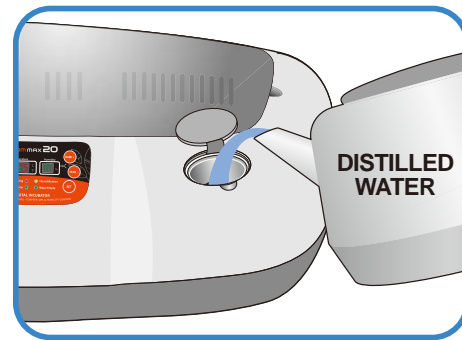
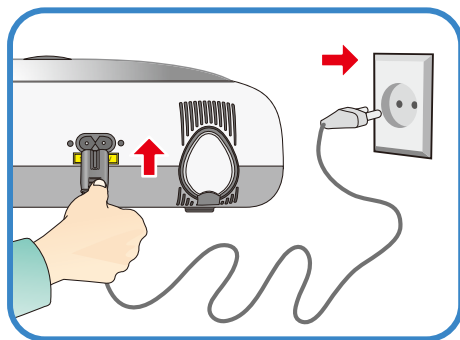

⚠ In case you use the incubator without adding humidification water or intend to incubate eggs at low humidity under RH 20%, you must stop its humidification function. please turn off the humidity unit if the unit is empty water otherwise, humidity unit will be broke or you may not no longer use the unit. (When using this function, the alarm for sensing water drop will go out.) [See the description of humidification function OFF on Page 12]

※ How to turn off Humidification Function : Set humidity level at RH 20%.

2. Before use

(2) What is an incubation room? / Preparation for Incubation

20

⚠ Some gap (about 2mm) around the eggs is needed for easy egg turning as shown on the below. ▼

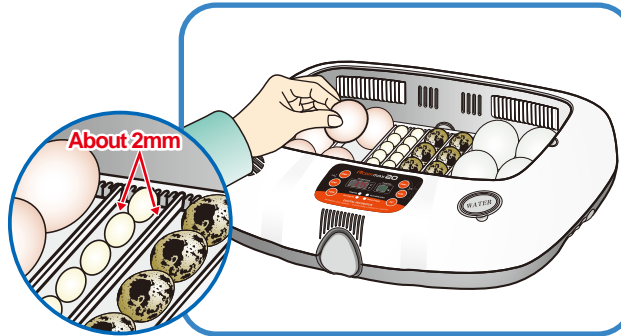

※ When you use the 'universal rolling divider' which is sold separately, be careful to adjust the distance of rolling divider so that eggs do not roll out of position. Refer to the picture right side.

⚠ If you use Mineral water or Tap water for humidification, the humidity unit can be broken easily because of water scales. We strongly recommend you to use only "DISTILLED WATER" for your machine, and Autoelex Co.,Ltd & our distributors do not indemnify for warranty service not only if you have any problem with using mineral water, regular water, tap water and the like but also if you had improper management or handling for your machine. In this case, Autoelex Co.,Ltd. & our distributors will charge for your after service.

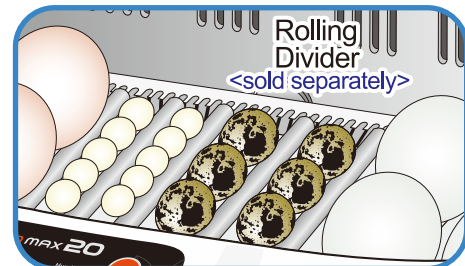

Tip You can buy the 'Distilled water' in your local market, and if you have any question, please contact the shop, where you purchased your machine.

3 Place the eggs to incubate in the egg groove and then close the view window.

⚠ Be careful to close the view window completely; if not, the temperature and humidity will fail to go up.

Tip The egg to incubate must be a fertilized egg. (Refer to the guidebook.)

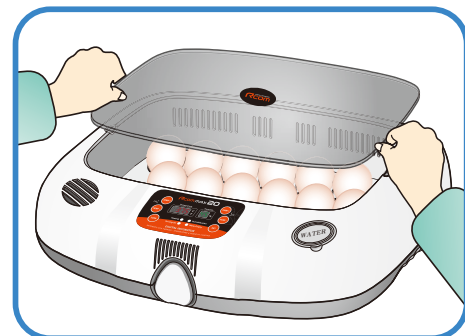

How to start incubation

- ▶ If you connect the incubator with power cord, second dot " ." of temp. display is blink with alarm. Press SET to remove blink and then it starts incubation with existing temperature and humidity.
[Factory default setting - Temp. : 37.5°C (99.5°F), Humidity : RH 45%]
- ▶ Be sure to turn ON egg turning before incubation starts and turn OFF before 3 days of hatching. At this time, it's recommendable to raise humidity up to 60~70%.
[Refer to Egg Turning ON/OFF on Page 13.]

Tip There can be some smell the first time you use the incubator, that is normal.

Tip Power Failure Notification : When firstly input power, or power failure during incubation, second dot " ." of temp. display is blink with alarm. Press SET to remove.

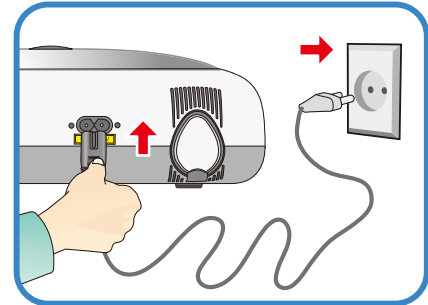

How to terminate incubation

- ▶ After all eggs are hatched, you should REMOVE the power cord for incubation termination.
(The incubator has no separate power switch.)

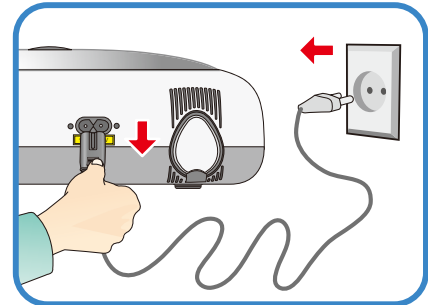

Return to factory settings

- ▶ It is for returning to the factory default setting.
- ▶ It is for initializing the incubator setting or calibration to the factory settings when you handle the incubator improperly so that the value has changed. Unplug the power supply and hold SET button and re-plug the power supply as shown on picture. Then, rSt will show on the display, and the incubator will be initialized to factory setting.

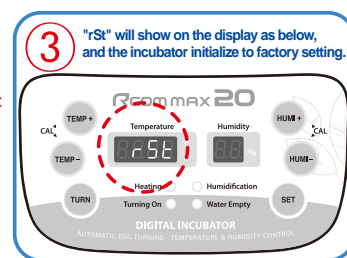
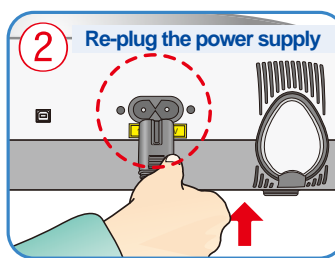
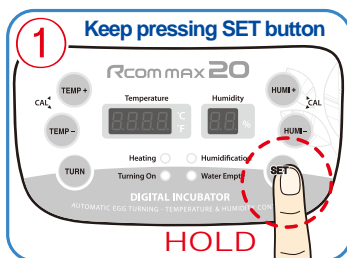

How to change Cels. & Fahr.

- ▶ Press **TEMP+** and **TEMP-** buttons at the same time and CA will show on Temp. display.
Then press **SET** button, it will change as shown on the right.

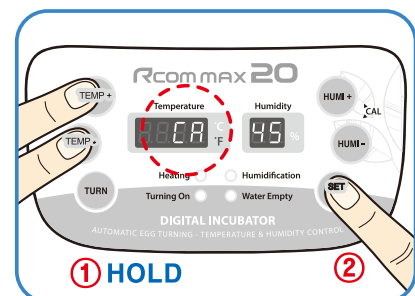

3. Function Settings

(3) Temperature & Humidity Setting / How to Set Egg-Turning

20

How to Set Temperature

- ▶ In a state of **SET** button being pressed, adjust the temperature you want with **TEMP+** or **TEMP-** button. Temperature setting will be completed when you remove your finger from the **SET** button, and the present temperature of the incubator inside will be indicated.

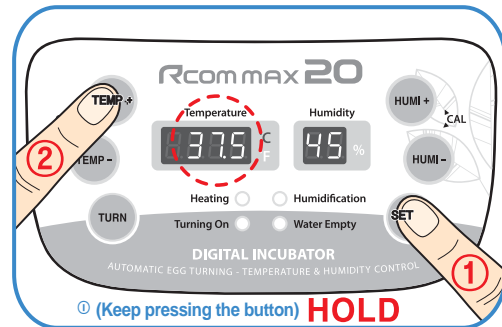

- Tip** If you set the incubator under a direct ray of light or too cold spot, the incubator temperature can be higher or lower than setting temperature.
- Tip** If you press **SET** button, the present setting temperature and humidity will be indicated and, if you remove your finger from the button, the present inner temperature and humidity indicated.

How to Set Humidity

- ▶ In a state of **SET** button being pressed, adjust the humidity you want with **HUMI+** or **HUMI-** button. Humidity setting will be completed when you remove your finger from the **SET** button, and the present humidity of the incubator inside will be indicated.

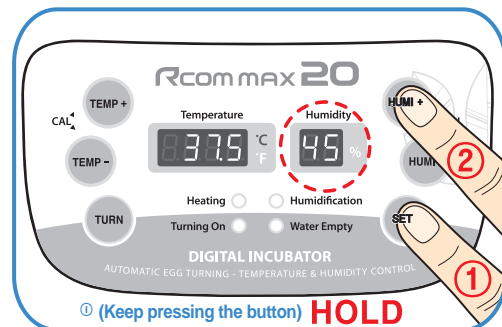

- ▶ Be sure to set humidity RH 65 ~ 70% from 1~3 days before hatching.
- Tip** Temperature and humidity can be different from normal setting levels according to the surrounding environment. (Refer to a incubation guidebook which is supplied separately.)
- Tip** Temperature and humidity is optimized when Rcom products are released. We do not recommend customers to recalibrate by their own. If you need to recalibrate, please visit our website (www.rcom.co.kr→Download→Manual) or ask purchase place. Because of low price thermometers and hygrometers are not accurate, we recommend you to use special calibrated thermo-hydrometer. (Poultry only thermo-hydrometer: check Rcom website: Digilog II)

How to Turn ON/OFF Humidification Function

- ▶ In a state of **SET** button being pressed, press **HUMI-** button to adjust humidity at RH 19% and, then, humidification function will be OFF. On the contrary, if you adjust humidity above RH 20%, its function will be ON.

- !** In case you use the incubator without adding humidification water or intend to incubate eggs at low humidity under RH 20%, you must stop its humidification function. please turn off the humidity unit if the unit is empty water otherwise, humidity unit will be broke or you may not no longer use the unit.

How to Set Abnormal High or Low Temperature Alarm

- ▶ What is Abnormal High or Low Temperature Alarm?
It is alarm sounds when incubator temperature is higher or lower than setting value because of various reasons such as room temperature change or disorder of temperature controlling system.

※ How to Set

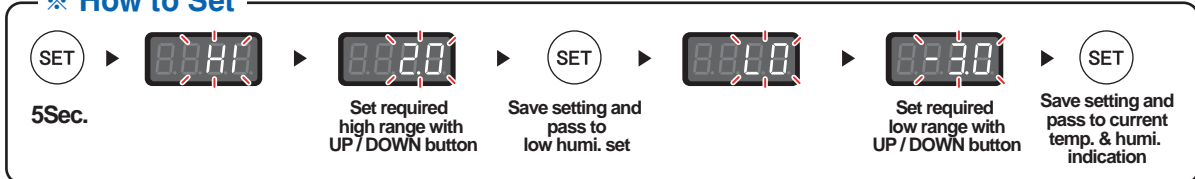

- * Max. abnormal temp. alarm limit (0.0 ~ 5.0°C Default Setting:2.0°C)
- * Min. abnormal temp. alarm limit (0.0 ~ -5.0°C Default Setting:-3.0°C)

How to Set Egg Turning ON/OFF

- ▶ Egg Turning Test : If you press **TURN** button for about 5 seconds, egg turning test will be effected once.
- ▶ In a state of **SET** button being pressed, press **TURN** button then the setting will be changed as required.

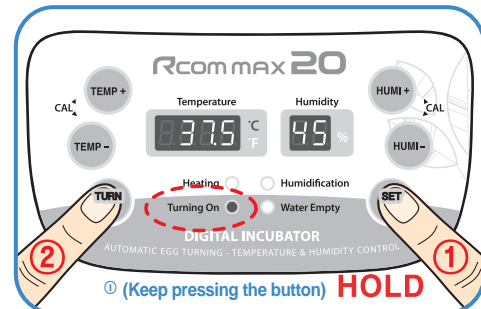

- ⚠ Be sure to set TURNING OFF 3 days before hatching.

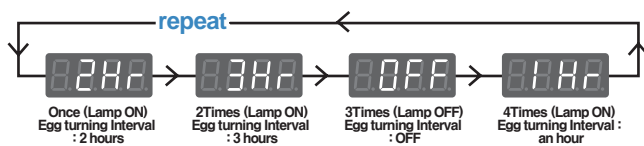

Egg Turning Melody ON / OFF

- ▶ Please press **TEMP+** button over 5 seconds to turn ON or OFF egg turning melody.



4. Incubation

(1) Humidity & Air Maintenance during Incubation / Maintenance after Hatching
(2) Dew Condensation

20

Humidity & Air Maintenance During Incubation

- ▶ When hatching, humidity should be relatively high to prevent the thin membrane from drying out or hardening before hatching.
- ▶ When hatching, it's recommended not to open the lid often. This is because if you open the lid often humidity will be rapidly decreased and it will take a long time to regain the proper humidity.
- ⚠ **Incubator internal temperature is 37°C (99.5°F) or more, and hatching room temperature is below 28°C, in that case, RH 70% humidity is may not be able. The difference of ±5% humidity value may occur from the humidity sensors difference, and there are no problems at hatching**
- ▶ It's very important to maintain humidity higher 1~2 days before hatching than the early and middle incubation periods. Humidity requirements during incubation are RH 45~55% for waterfowl, RH 40~45% for poultry and RH 35~45% for parrot, in general. One day before hatching, all kinds of birds need about RH 65% humidity and sometimes need higher than that. However, in areas of high ambient humidity, lower levels of humidity may be needed during incubation.

Tip It's very important to keep humidity higher than RH 60% before hatching 3days.

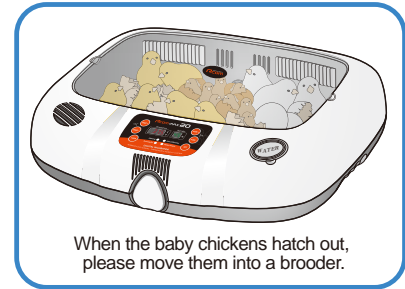
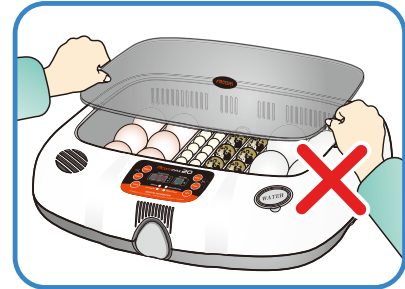

Maintenance after Hatching

- ▶ It is necessary to use a brooder for baby chicken or bird since they are too week against cold or cool environment. If you try egg-hatching in your incubator, there would be lots of germs, feathers, which causes of low egg hatching possibility for your next hatching. Also, they can make your incubator broken or faulty. We strongly recommend you to use independent Hatcher or Brooder for egg-hatching. If you have any faulty or broken because of not using independent Hatcher or Brooder, we do not serve you the free warranty service. In other words, you have to pay for the service charge. To make a simple Hatcher or Brooder, please refer to the our web-site (www.Rcom.co.kr).
- ⚠ **Please do not try to egg-hatching in the incubator. It makes your incubator broken or faulty, and we do not give you free warranty service. (Please move all the eggs 1~3 days before hatching into Hatcher or Brooder.)**
- Tip** **Hatcher** : The machine for egg-hatching. Operate it 1~3 days before egg-hatching. (Rcom MARU H&B)
Brooder : The machine makes baby chickens or birds warm up against cold or cool environment. You can set up proper temperature and humidity. (Rcom MARU H&B / Rcom Brooder Series)
- ▶ As there is some difference in chick feed for each kind of bird, so it's desirable to obtain useful information about the chicks before hatching.

- ⚠ **Be sure to use a three-wavelength 20W bulb. If you use a bulb over 20W. temperature goes up, possibly killing the chick or causing a fire. If there is too much water and a chick would falls into water, its feathers get wet and it can be died of loss of body heat. Here, dry feathers with a hairdryer. etc**
Be sure to use a three-wavelength 20W bulb :
In case breeding room size 370 x 270 x 130(mm)

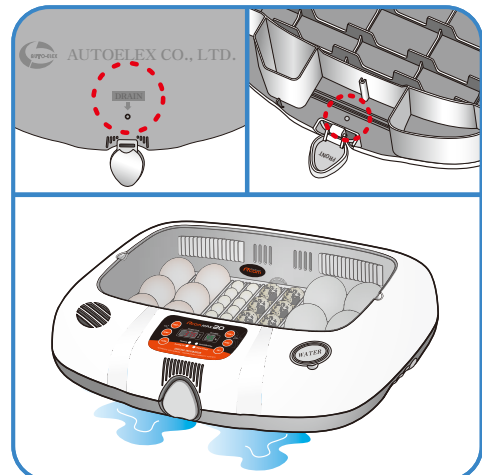

Dew Condensation

This is a naturally occurring phenomenon when there is a significant difference in temperature between inside and outside of the incubator during incubation period. If this occurs, water may form in inside bottom of the main body of the incubator(bottom part).

- ▶ Pull out the electric cord from the connecting jack and also take out the plug from the outlet.

! Don't turn off the power soon after using the incubator, as this may cause a break down due to moisture left inside the main controller. At this time, it's better to firstly remove the water inside of the incubator and dry by operating it for 1 hour and then turn it off or open the view window and dry it naturally for 2~3 hours and, then, re-operate it, which may lengthen the life time of incubator.
(Set humidification function OFF. / Refer to the page 12.)

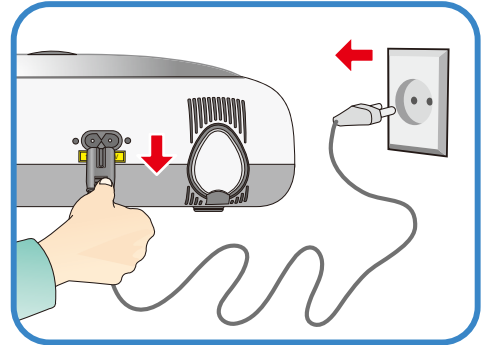

How to disassemble and clean the incubator

1

Unlock and remove the locking buttons for three parts at the front and back of incubator by pulling them forward.

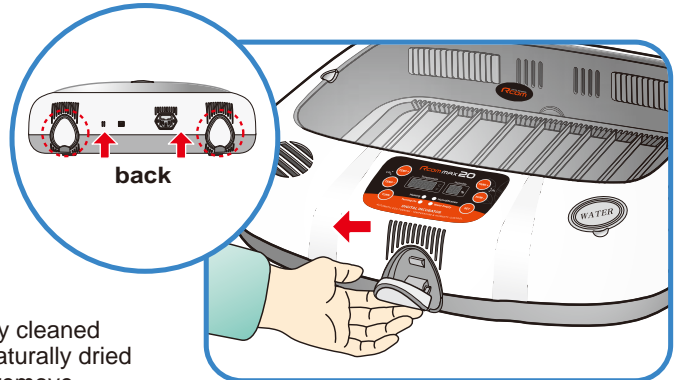

2

The bottom part of incubator should be thoroughly cleaned with water and dried. The upper part should be naturally dried in the well-ventilated place for about one day to remove moisture left inside of the incubator after hatching thoroughly.

! Don't clean the product with organic solvents such as benzene, thinner, etc. which may cause deformation or decoloration of the plastic parts.

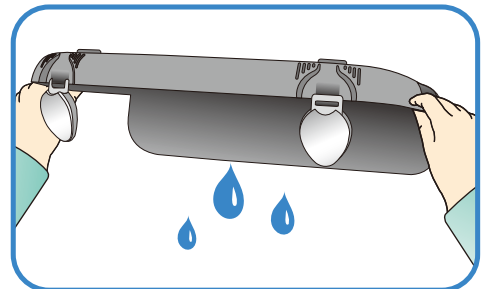

3

- ▶ When using humidification function, a lot of alien matter sticks to the humidification heating element [Ⓐ]. This may not cause failure, but when terminating incubation please clean the humidifying heater lightly with a soft brush.
- ▶ If you place the main body(upper part) on the floor, please don't let the humidification heating part touch with the floor.

! If you inflict impact on the humidification heating part or scrape it with a sharp instrument, the humidifying heater will be damaged.

! We kindly recommend you to use distilled water In order to reduce a foreign substance on the humidifying heater device.

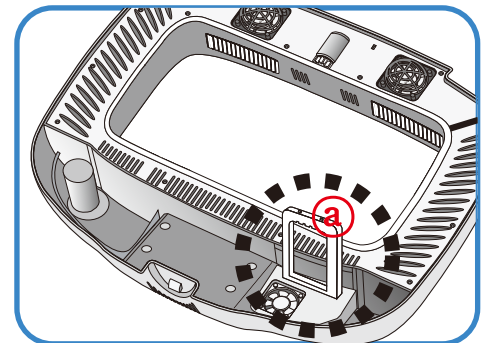

5. How to Clean

(2) How to Clean

20

4

Start the vacuum cleaner to remove the dust as shown on the right and thoroughly shake out the minute dust with a fine brush.

Tip If the incubator goes through incubations several times, feather, dust, shell, etc. accumulate inside the main body, which may cause a break down, so be sure to clean the product before storage.

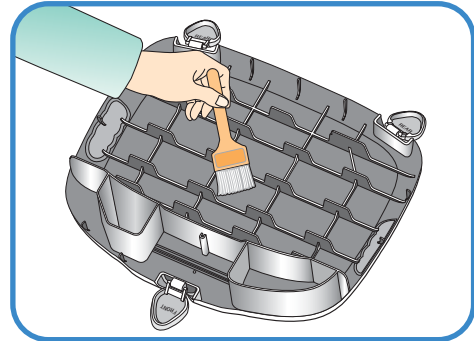

! In case the incubator clean status is poor which may cause fan noisy or stopping.

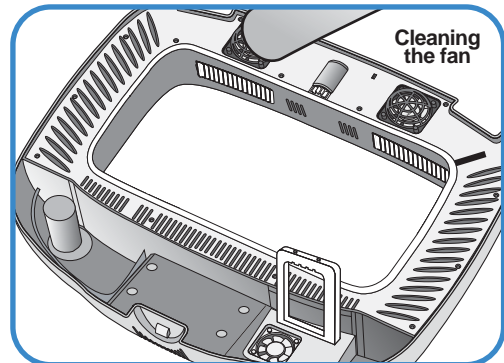
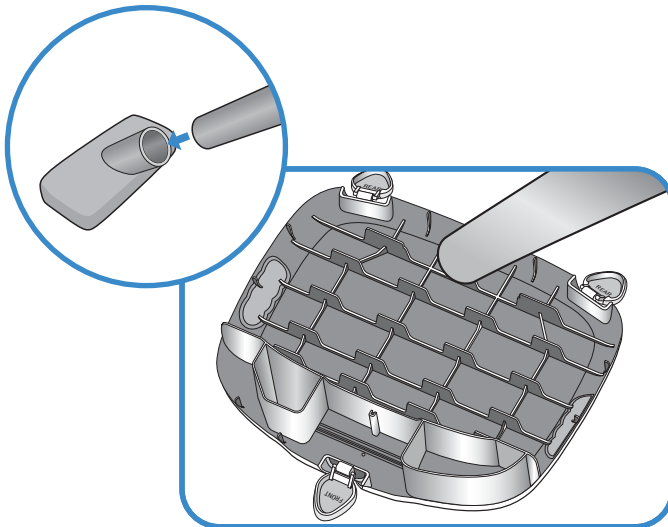

5

If you finish cleaning the incubator, reassemble it in the reverse order of disassembly. Wipe out outside the main body with a wet cloth and dry it in a cool and well-ventilated place before storage.

Tip [Refer to How to assemble on Page 8.]

! Don't clean the product with organic solvents such as benzene, thinner, etc. which may cause deformation or decoloration.

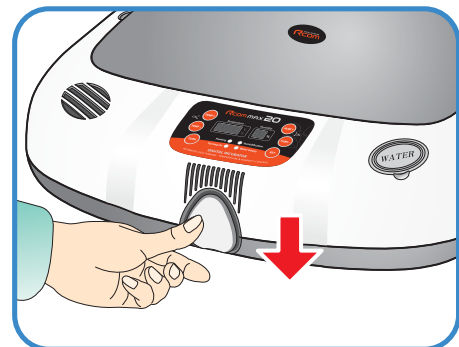

Servicing

All our Rcom digital incubators of Autoelex Co., Ltd. are made by precision systems under strict quality control. But occasionally some defective products are found on the way of their distribution. If any problem occurs, then please contact Rcom service center or distributors in your country. We will do our best to solve the problems, if any, for you. This product is designed in modular mode, so for its repair, if any, a qualified person can replace the part concerned with ease.

Frequently Asked Questions (FAQ)

Troubles	Expected Causes (Possibility)	Countermeasures
In case hatching rate is low	<ul style="list-style-type: none"> ▶ When the egg is an unfertilized egg. ▶ Getting infected by germs ▶ Wrong incubation setting ▶ Health condition of mother bird ▶ Improper egg turning 	<ul style="list-style-type: none"> ▶ Inspect the egg to check possibility of egg surviving. ▶ Disinfect the incubator. ▶ Check all settings of incubator. Especially, check them focusing on the temperature. ▶ Review care of health of mother bird. ▶ Check if egg turning is normal.
When a chick hatches out earlier than expected or a deformed chick hatches out	<ul style="list-style-type: none"> ▶ Setting temperature high ▶ Egg turning was not operating normally 	<ul style="list-style-type: none"> ▶ Lower temp. setting of the incubator about 0.5°C (1°F) ex) 37.5°C (99.5°F) → 37.0°C (98.6°F) ▶ Check if egg turning function is OFF
When a chick hatches out later than expected	<ul style="list-style-type: none"> ▶ Setting temperature low 	<ul style="list-style-type: none"> ▶ Raise temp. setting of the incubator about 0.5°C (1°F) ex) 37.0°C (98.6°F) → 37.5°C (99.5°F)
When hatching dates are so different from each egg (When all chicks don't hatch out at the same time but over a long period)	<ul style="list-style-type: none"> ▶ Eggs stored for different lengths of time ▶ Different incubation temperatures 	<ul style="list-style-type: none"> ▶ Minimize the time to store egg properly. ▶ Check Temperature difference in the incubator. (sunlight, temp of incubation room, etc.)
When intending to hatching various eggs at the same time	<ul style="list-style-type: none"> ▶ Incubation days are different, so hatching rate falls down. ▶ Eggs might be contaminated by chicks that hatched first. 	<ul style="list-style-type: none"> ▶ Mark hatching date on eggs and move them to other incubator (brooder) just on the marked date. ▶ In case of putting in many eggs at the same time, it's convenient to prepare a spare incubator available as a brooder

Troubleshooting

If you need detail self diagnosis, please click "self diagnosis" on our website.

CIRCUMSTANCE	ITEMS TO BE CONFIRMED	SOLUTIONS
No signs of power to the incubator.	<ul style="list-style-type: none"> ▶ Check electric cord is properly connected. ▶ Check if there is a power outage. ▶ Check whether the plug is damaged. 	<ul style="list-style-type: none"> ▶ Connect the cord again. ▶ Check the main socket with any other electric appliances. ▶ Try to insert to another outlet.
Temperature will not go high enough.	<ul style="list-style-type: none"> ▶ Check your setting temperature. ▶ Check the air circulation FAN is working. ▶ Initialize the incubator. [Refer to the page 11] 	<ul style="list-style-type: none"> ▶ Set the temperature as required. ▶ Take the power plug out of the outlet, and disassemble the main body for cleaning around the air circulation fan with brush.
Alarm sounds with HI indication (abnormal high temp.)	<ul style="list-style-type: none"> ▶ Check if room temperature is too high ▶ Check if incubator is exposed to the direct rays of sun 	<ul style="list-style-type: none"> ▶ Adjust room temperature 28°C (82.4°F) ▶ Install incubator without the direct rays of sun ▶ Return incubator to factory setting [Refer to page 11]
Alarm sounds with LO indication (abnormal low temp.)	<ul style="list-style-type: none"> ▶ Check if room temperature is too low ▶ Check if incubator heater(temperature controlling-system) is normally working 	<ul style="list-style-type: none"> ▶ Adjust room temperature 28°C (82.4°F) ▶ Place thermometer inside of incubator and check if setting temperature is correct ▶ Return incubator to factory setting [Refer to page 11]
Humidity will not go high enough.	<ul style="list-style-type: none"> ▶ Check your setting humidity. ▶ Close the view window again after checking. ▶ Initialize the incubator. [Refer to the page 11] 	<ul style="list-style-type: none"> ▶ Supply water. ▶ Set the humidity again as required.
The machine makes some noise. - It is normal that the machine emits some sounds because it uses air circulation fan for working.	<ul style="list-style-type: none"> ▶ Check if there is any hatching debris such as feather or eggs-shell in the incubator FAN. 	<ul style="list-style-type: none"> ▶ Take out the plug out of the outlet and disassemble the main body and clean around the air circulation fan with brush.
Egg-Turning fails to work.	<ul style="list-style-type: none"> ▶ Check that the Egg-turning stoppage is not activated. (Egg-turning lamp lighting) ▶ Check that there are no foreign items on the egg turning tray. ▶ Check if egg turning plate is assembled correctly. [Refer to the page 9] 	<ul style="list-style-type: none"> ▶ If you need to turn the eggs, you can manually re-start egg-turning. ▶ Unplug the power supply and disassemble the main body for cleaning the egg turning tray and gear. ▶ Assemble egg turning plate as the picture on page 9.
Dew foams in the incubator.	<ul style="list-style-type: none"> ▶ Check the incubator is not placed too cold circumstances. ▶ When you turn OFF incubator and then turn on. 	<ul style="list-style-type: none"> ▶ Move the incubator to where the ambient air temperature is over 28°C (82.4°F) ▶ Dew condensation is normal. ▶ Dry the incubator completely under well ventilated place.
Water leaks from the machine.	<ul style="list-style-type: none"> ▶ Check that you have not overfilled the incubator. ▶ Check that the incubator placed on inclined surface. ▶ Check if it is Dew condensation 	<ul style="list-style-type: none"> ▶ Do not fill water over LIMIT indication. ▶ Place incubator under a level surface.



Be sure that the incubator works without any problem before placing eggs in the incubator.

Specification

1-1 NAME : Rcom MAX 20
1-2 MODEL NO. : MX-20

Power	AC 100 ~ 120[V], 50/60[Hz] AC 220 ~ 240[V], 50/60[Hz]	
Temp. limits	20.0 ~ 42.0[°C]	
Working Temperature	Ideal:20 ~ 25[°C]	Min. 15[°C] / Max. 30[°C]
Humidity Limits	20 ~ 70[%] (It can be changed according to the conditions)	
Power Consumption	Average. 48[W]	MAX. 65[W]
Egg-Turning Interval	Various according to the tray	
Capacity	For all size egg : Various sized egg incubation is: Universal tray (Included) available Small : 52 [EA] (Quail egg size) : Small egg tray (option) Standard : 20 [EA] (Chick egg size) : Standard egg tray (option) Large : 10 [EA] (Goose egg size) : Large egg tray (option)	
Net Weight	4.35[kg]	
Size	(W)500 × (L)410 × (H)160 [mm]	
Fuse Standard	250[V] 2.0[A] (Ø5 × 20[mm])	

- ⚠ You will be asking for service charge if you are in below cases.**
1. Broken or Problem caused by 'No cleaning' or 'Improper handling'
 2. Broken or problem caused by 'Not using distilled water'
 3. Broken or problem caused by 'Trying Bird hatching in incubator'
(Please don't try bird hatching in incubator. Please use Hatcher during bird hatching.)
 4. Broken or problem caused by 'Wrong controlling(Using)'
 5. Broken or Problem caused by using the machine out of User's Manual.
 6. Broken or problem caused by 'Customer's mistake or fault'

- ※ Register your product Serial No. on our website for free 2 years gurantee.
- ※ Refer to website for how to register. (Free 1 years gurantee in case not registerd.)

- ※ Product Registration Procedures
 If you are a new member of Rcom, you need to log in our website at www.Rcom.co.kr
1. Click "SIGN UP" on top of the right corner.
 2. Fill out the information on the blanks.

- If you already registered your information on the Rcom website, please log in to www.Rcom.co.kr.
1. Click "Login" on top of the right corner.
 2. Select "Customer" and click "Register Products".
 3. Fill out the information on the blanks.

- You will need below information to register on our website.
1. Your name
 2. Your (home/company) address & Email address, country
 3. Your product(model) name & Serial number
 4. Date of purchase & Name of purchased shop you bought from

Rcom USB 20, PRO 20, MAX 20 PART LIST

Image	Part No	Names of goods (*Compatible)	Image	Part No	Names of goods (*Compatible)
	H20-F201-10	H20 Body		H50-H611-10	H50 Humi Heater Cover
	H20-A202-10	H20 Bottom ASM		H20-A216-10	H20 Humidity Unit ASM
	H20-F203-10	H20 Slide		RCM-700-10	Silicon Tube
	H20-A200-10	H20 Window ASM		K20-H512-10	Heat Support -A
	H20-A218P-10	H20 PRO Main PCB ASM		H50-H612-10	Heat Support -B
	H20-A218U-10	H20 Main PCB USB ASM		H20-A234L-10 H20-A234H-10	H20 Silicon 110HEATER ASM H20 Silicon 220HEATER ASM
	H20-A218M-10	H20 MAX Main PCB ASM		H20-AF212-10	H20 Front Lock ASM
	H20-A219-10	H20 SMPS PCB ASM		H20-AF211-10	H20 Rear Lock ASM
	RCM-A310-10	TH V2 Sensor ASM		H20-F240-10	H20 Air Fin
	H20-F206-10	H20 Main PCB Cover		H20-F229-10	H20 Water Cap

※ Partly spare parts are not on the parts list.

Rcom USB 20, PRO 20, MAX 20 PART LIST

Image	Part No	Names of goods (*Compatible)	Image	Part No	Names of goods (*Compatible)
	H20-F237-10 (Option)	H20 Brooding Tray (*For reptile incubator)		H20-F219P-10 (R90-F219M-10)	H20 PRO Membrane SW (R90 Pro type)
	H20-F210-10	H20 Universal Tray		H20-F224-10	H20 Pinion Gear
	H20-F233-10	ABS Divider(No.2)		H20-F223-10	330 Geard Motor
	H20-F234-10 (option)	H20 Roller Divide		H20-F214-10	Humi BLDC FAN40
	H20-F208-10	H20 Standard Tray		H20-F226-10	BLDC FAN50
	H20-F207-10	H20 Large Tray		H20-304XX-10	Power Coard(8)
	H20-F209-10	H20 Small Tray		H20-H686-10	H20 Rubber Foot
	H20-F219M-10 (R90-F219M-10)	H20 MAX Membrane SW (R90 Max type)		H20-F239-10	H20 Styrofoam Ball
				H20-F244-10 (Option)	H20 Hatching Pad
				RCM-347-10	USB Cable

※ Partly spare parts are not on the parts list.

Rcom Incubator Series

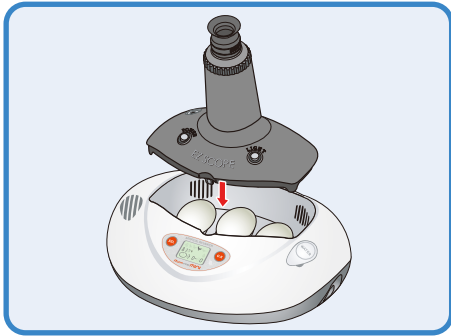

Rcom PRO MINI (PX-03)

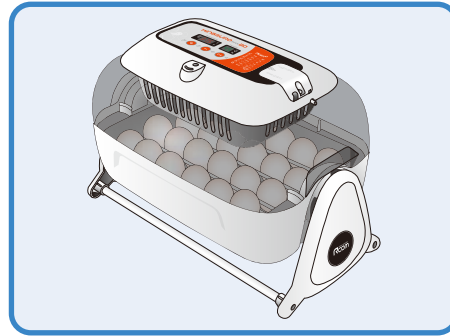

Rcom KINGSURO MAX 20 (MX-SURO)

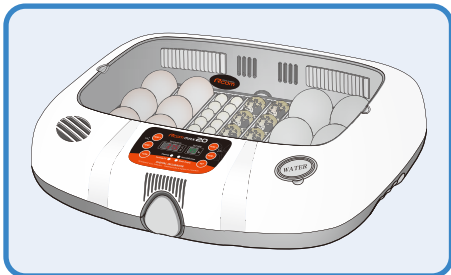

Rcom MAX 20 (MX-20)

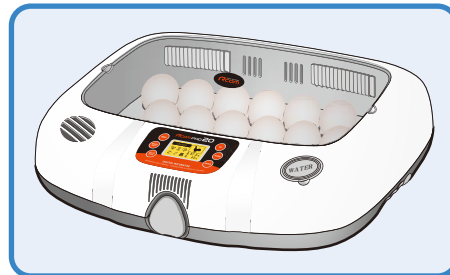

Rcom PRO 20 (PX-20)



Rcom reptiles PRO 90 (PX-R90)

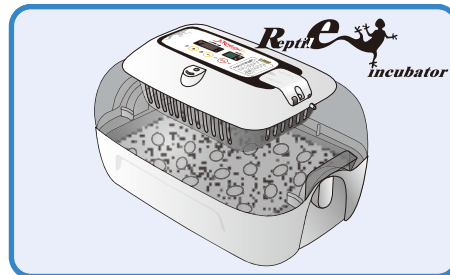

Rcom reptiles MAX 60 (MX-R60)

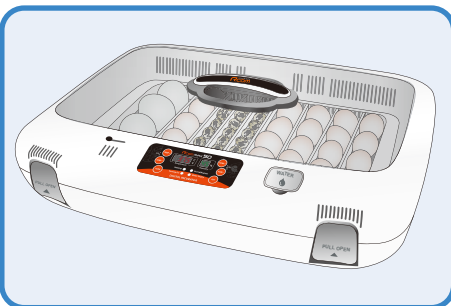

Rcom MAX 50 (MX-50)

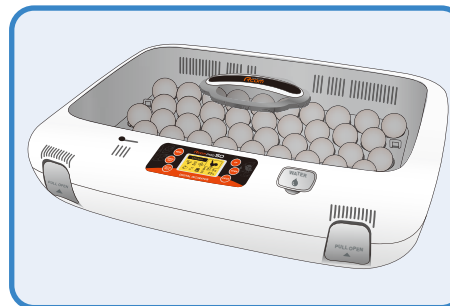

Rcom PRO 50 (PX-50)



Rcom BROODER&ICU
(MX-BS500(N))



Rcom DIGILOG
(PX-V1)



Rcom DIGILOG2
(PX-V2)

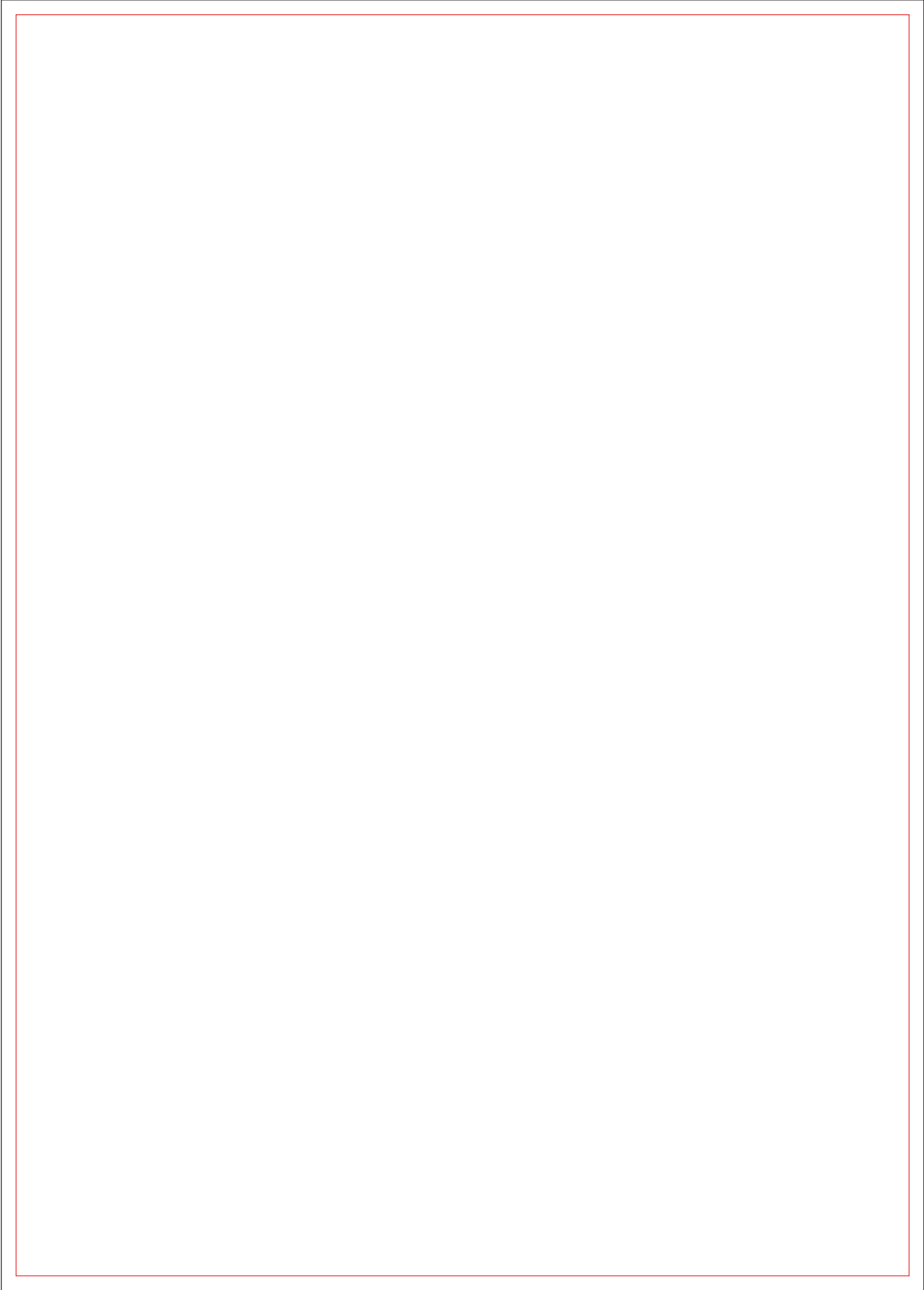

Rcom is designed for user's easy and convenient use,
It can be changed without notice for improvement in performance,
design,treatment, and software, etc.



www.RcomCo.com



North America Sales & Service

www.RcomCo.com

MANUFACTURER



OFFICE : [F1] Deogam 612 Juchon Gimhae
Gyeongnam 621-843 Korea [F2] 3,
Yanggeun-ro 287beon-gil, Yangpyeong-eup,
Yangpyeong-gun, Gyeonggi-do, Korea

AUTOELEX CO.,LTD.

Rcom is the Best Design with High Quality, Value, and Performance!